

KUTE™ 44

FPD8547**

44" Ceiling Fan

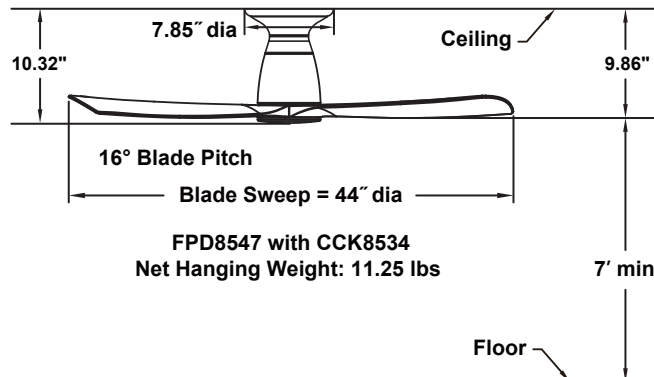
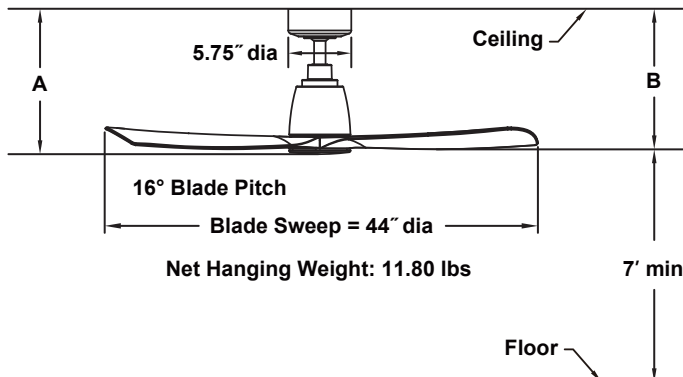

INSTALLATION REQUIREMENTS:

Fan must be attached to a securely anchored electrical junction box capable of withstanding a load of at least 35 lbs.

ELECTRICAL REQUIREMENTS:

Requires a grounded electrical supply line of 120 volts AC, 60 Hz, 15 amp circuit.

MOTOR SPECS:

100 x 30 sensorless DC motor is designed for optimal performance with this fan.

BLADES:

A set of three 21" composite blades is included.

CONTROL OPTIONS:

A WiFi receiver and TR305 hand-held remote control are included. Push button remote control with 16 fan speeds, fresh air, reverse, ON/OFF dimmer light levels, CCT Select (correlated color temperature selection), fan/light timer, home away, safe exit and off button. Visit the Apple APP Store or Google Play Store to download the free fanSync WiFi APP and create your Fanimation fanSync account. Optional TW306 wall control is available — sold separately. Instructions are provide with each control.

LIGHTING OPTIONS:

LK8534 - One 16-watt CCT LED (3000K/4000K/5000K).

DOWNROD OPTIONS:

Fan comes with a 1" dia. x 4.5" long downrod (DR1-45). Optional downrods are available in 12", 18", 24", 36", 48", 60" and 72" lengths. A downrod coupler is available for installations requiring a downrod longer than 72". Fan can be mounted on a sloped ceiling up to 27°. Most sloped ceiling installations require a standard 18" downrod or longer downrod. Optional sloped ceiling ball kits (SCB1-52) are available for slope angles greater than 27° and up to 42°. Optional close-to-ceiling kit (CCK8534) is available as well — sold separately. Call technical support for more information.

LOCATION USE:

Fan is rated for dry and damp locations. This fan is for room up to 225 sq ft.

	A	B
Fan w/4.5" downrod	13.10"	12.64"
Fan w/12" downrod	20.60"	20.14"
Fan w/18" downrod	26.60"	26.14"
Fan w/24" downrod	32.60"	32.14"
Fan w/36" downrod	44.60"	44.14"
Fan w/48" downrod	56.60"	56.14"
Fan w/60" downrod	68.60"	68.14"
Fan w/72" downrod	80.60"	80.14"

Available Finishes	
BL	Black with Black Blades
BN	Brushed Nickel with Brushed Nickel Blades
BS	Brushed Satin Brass with Matte White Blades
BSBL	Brushed Satin Brass with Black Blades
DZ	Dark Bronze with Dark Walnut Blades
GR	Matte Greige with Weathered Wood Blades
MW	Matte White with Matte White Blades

Airflow / Energy Efficiency Info (120V)					
Fan Speed	Max RPM	CFM	CFM / Watts	Amps	Watts
High (16 th)	213	5490	213	0.40	26
Med (9 th)	128	3226	475	0.11	7
Low (1 th)	30	442	198	0.05	2

Energy Guide FTC			
Power (W _{ave})	Total Air Delivery (CFM _{ave})	Estimated Yearly Energy Cost (\$)	Ceiling Fan Efficiency (CFM/W)
17	3729	5	216